

LA-745

Series..A



PUBLICLY RELEASABLE

Per M. M. Keatz, FSS-16 Date: 3-13-96  
By J. D. B., CIC-14 Date: 4-2-96

LA-745

Series A



August 18, 1949

This document contains 52 pages

OPTICAL AND MORPHOLOGICAL CRYSTALLOGRAPHY  
OF PLUTONIUM COMPOUNDS

Classification changed to UNCLASSIFIED  
by authority of the U. S. Atomic Energy Commission,  
Per Jack D. Kahn 6-13-56  
J. Matting  
By REPORT LIBRARY 9-20-56

By

Eugene Staritzky  
A. L. Truitt

Chemistry Transuranic  
Elements



UNCLASSIFIED



TABLE OF CONTENTS

	PAGE
Abstract.....	4
I. Introduction.....	5
II. Health Precautions.....	5
III. Methods.....	6,7
IV. Presentation of Data.....	8-15
V. Crystallographic and Optical Data.....	15-42
1. Plutonium (IV) Dioxide.....	15
2. Plutonium (IV) Peroxide.....	16
3. Plutonium (IV) Peroxide Sulfate (?).....	17
4. Plutonium (III) Tri-Fluoride.....	17,18
5. Plutonium (IV) Tetra-Fluoride.....	18
6. Plutonyl Di-Chloride Hydrate.....	18,19
7. Di-Cesium Plutonium (IV) Hexa-Chloride.....	19,20
8. Ammonium Plutonyl Tri-Nitrate.....	20,21
9. Di-Ammonium Plutonium (IV) Hexa-Nitrate.....	21,22
10. Di-Potassium Plutonium (IV) Hexa-Nitrate.....	22,23
11. Di-Rubidium Plutonium (IV) Hexa-Nitrate.....	23
12. Di-Thallous Plutonium (IV) Hexa-Nitrate.....	24
13. Di-Cesium Plutonium (IV) Hexa-Nitrate.....	24,25
14. Magnesium Plutonium (IV) Hexa-Nitrate Octo-Hydrate....	25,26
15. Zinc Plutonium (IV) Hexa-Nitrate Octo-Hydrate.....	26
16. Cobalt Plutonium (IV) Hexa-Nitrate Octo-Hydrate.....	26,27
17. Nickel Plutonium (IV) Hexa-Nitrate Octo-Hydrate.....	27
18. Di-Plutonium (III) Tri-Sulfate Hepta (?) - Hydrate....	28
19. Plutonium (III) Sulfate (?). Triclinic Form.....	28,29,30
20. Plutonium (IV) Di-Sulfate Tetra-Hydrate.....	30,31
21. Di-Ammonium Di-Plutonyl Tri-Sulfate Penta-Hydrate....	31,32
22. Sodium Plutonyl Tri-Acetate.....	32
23. Sodium Zinc Tri-Plutonyl Nono-Acetate Hexa-Hydrate....	32,33
24. Di-Plutonium (III) Tri-Oxalate Nono (?) - Hydrate....	33-34
25. Plutonium (III) Oxalato-Chloride.....	34
26. Plutonium (IV) Di-Oxalate Hexa-Hydrate.....	34,35
27. Plutonyl Oxalate Tri-Hydrate.....	35,36
28. Bismuth (III) Plutonium (IV) Oxalate.....	36,37
29. Plutonium (III) Succinate.....	37
30. Di-(Tetramethyl Ammonium) Plutonium (IV) Hexa-Chloride (Tetragonal Form).....	37,38
31. Di-(Tetramethyl Ammonium) Plutonium (IV) Hexa-Chloride (Isometric Form).....	38
32. Di-(Tetraethylammonium) Plutonium (IV) Hexa-Chloride..	39
33. Di-Pyridinium Plutonium (IV) Hexa-Chloride.....	39,40
34. Di-Quinolinium Plutonium (IV) Hexa-Chloride.....	40
35. Plutonium (IV) 8-hydroxyquinonolate.....	40,41
36. Plutonium (III) Picrolonate (Orthorhombic Form).....	41,42
37. Plutonium Picrolonate (?) (Triclinic Form).....	42
VI. References.....	43,44

ILLUSTRATIONS

	<u>PAGE</u>
Fig. 1: Crystal habit of ammonium plutonyl tri-nitrate	45
Fig. 2: Crystal habit and optic orientation of di-ammonium plutonium hexa-nitrate	45
Fig. 3: Crystal habit of magnesium plutonium hexa-nitrate octo-hydrate.	45
Fig. 4: Simple twin of sodium zinc plutonyl acetate	45
Fig. 5: Crystal habit and optic orientation of plutonium dioxalate hexa-hydrate	46
Fig. 6: Crystal habit of di-(tetra-ethyl ammonium) plutonium hexa-chloride	46
Fig. 7: Crystal habit and extinction angles of di-quinolinium plutonium hexa-chloride.	46
Fig. 8: Crystal habit and optic orientation of plutonium 8-hydroxyquinolate	46
Fig. 9: Crystal habit and optic orientation of plutonium (III) picrolonate	46
Fig. 10: Photomicrograph of di-caesium plutonium hexa-chloride	47
Fig. 11: Photomicrograph of magnesium plutonium hexa-nitrate	47
Fig. 12: Photomicrographs of di-ammonium plutonium hexa-nitrate	48
Fig. 13: Photomicrographs of di-ammonium plutonium hexa-nitrate	48
Fig. 14: Photomicrograph of plutonium (III) sulfate?	49
Fig. 15: Photomicrograph of di-plutonium tri-sulfate hepta (?) -hydrate	49
Fig. 16: Photomicrograph of plutonium di-sulfate tetra-hydrate	50
Fig. 17: Photomicrograph of diplutonium tri-oxalate nono (?) -hydrate	50
Fig. 18: Photomicrograph of plutonium di-oxalate hexa-hydrate	51
Fig. 19: Photomicrograph of plutonium di-oxalate hexa-hydrate	51
Fig. 20: Photomicrograph of plutonium oxalato-chloride	52

UNCLASSIFIED

ABSTRACT

Optical and morphological characteristics of thirty seven compounds of plutonium studied by methods of optical crystallography are described. The uniform method adopted for reporting such data is discussed.

UNCLASSIFIED

## INTRODUCTION

A systematic study of optical and morphological characteristics of plutonium compounds was begun in March 1948. The primary object of this work was to collect data which would permit the use of a polarizing microscope for the identification and study of such compounds in unknown samples. This report covers the work completed to date. It is planned to continue this study of plutonium compounds and to report additional data obtained from time to time.

## HEALTH PRECAUTIONS

It is necessary that extreme care be taken when handling plutonium compounds. The reader is referred to the instructions given in "Health Program for D Building Laboratory Area" printed September 15, 1947 and the special precautions given in the LA Report 416. These reports cover protective clothing, respirators, use of dry boxes and similar information necessary for safe handling of radioactive materials. It is essential that the operator take every precaution to avoid inhaling or ingesting plutonium even in the most minute amounts.

## METHODS

Standard methods of petrography and chemical microscopy (1), (2), (3), (4) were used in this investigation except as follows: Determination of refractive indices of radioactive substances by the immersion method necessitated the use of special microscope object glasses made by the Fish-Schurman Corporation. These slides had an annular groove, 3/8 inch inside diameter, 3/32 inch wide and about 1/64 inch deep ground into one surface. By taking up the excess immersion liquid, the groove prevented the radioactive contamination from reaching the edge of the cover glass. For use on the universal stage the edge of the cover glass was cemented to the slide outside the groove with sodium silicate. The double variation method was not used partly because of the unavailability of some items of equipment, but chiefly because some problems of adapting this method to the handling of radioactive substances have not yet been solved.

The characteristic absorption spectra of plutonium compounds suggest a wider use of the microspectrograph than is common in studies of this kind. The only instrument available for the study of absorption spectra of individual crystals was a Leitz prism microspectrometer which proved quite useful in

~~\_\_\_\_\_~~  
~~\_\_\_\_\_~~  
~~\_\_\_\_\_~~  
UNCLASSIFIED

spite of its limitations. An attempt is being made to obtain a more suitable grating microspectrograph, such as described by Jelley<sup>(5)</sup> for future studies.

~~\_\_\_\_\_~~  
~~\_\_\_\_\_~~  
~~\_\_\_\_\_~~  
UNCLASSIFIED



## PRESENTATION OF DATA

The following is an outline giving the order in which data are presented, the conventions adopted and notations used. In a general way recommendations of the Armour Research Foundation for presenting crystallographic data<sup>(6)</sup> have been followed with some amplifications, though in some particulars deviations from the recommended procedures seemed advisable.

1 a. Name of Compound and Chemical Formula.

Cunningham's<sup>(7)</sup> designations have been followed in this respect when compounds have been prepared according to the method given in this reference unless definite evidence for a different identification is available. In accordance with common usage Cunningham's designation "plutonium (VI) dioxy" for  $\text{PuO}_2$  has been changed to "plutonyl". Some compounds, not listed by Cunningham, have been prepared the identification of which appeared certain because of isomorphism with known salts of other elements. In still other cases the basis for identification, such as method of preparation, chemical properties, etc., is given.

1 b. Method of Preparation is described briefly with appropriate references.

1 c. Isomorphous Relations to compounds of other elements

are stated. Note is also made of any polymorphism observed.

2. Crystal Morphology: Up to now no goniometric measurements have been made on crystals of plutonium compounds. Because of the necessity of working with small amounts of material it is probable that in the future such measurements will be feasible only in a few cases of compounds crystallizing with exceptional ease. For this reason, and in order to facilitate the description of crystal habit and optic orientation, it seemed desirable to present whatever crystallographic data could be secured from microscopic observations and angle measurements on the stage, even though the values determined be of low precision.

2a. Crystal System can usually be determined by a combination of microscopic observations of crystal form and optical properties. In cases of doubt the system assigned is that of highest symmetry consistent with observations, and is then prefixed by the adverb "probably." Thus, "probably monoclinic" signifies that the compound may crystallize in the monoclinic or triclinic systems but not in the orthorhombic or in systems of higher symmetry. Rhombohedral crystals are regarded as belonging to a system separate from the hexagonal, and are characterized by the angular parameter alpha ( $\alpha$ ). If hemihedral development is observed the

crystal class is given; otherwise it is to be assumed that no observations have been made which are inconsistent with regarding the compound as crystallizing in the highest symmetry class of the given system.

2 b. Morphological Elements, unless otherwise stated, are based on measurements under the microscope and, as noted above, are to be regarded as rough approximations. The conventional elements (a : b : c,  $\alpha$ ,  $\beta$ ,  $\gamma$ ) are given and, in addition, such interzonal angles as are particularly characteristic of the appearance of crystals under the microscope. The extended Naumann rule (c < a < b), amplified for triclinic crystals by the rule suggested by Donnay<sup>(8)</sup> ( $\alpha$  and  $\beta$  obtuse), is generally followed except when superceded by the customary orientation of the unique symmetry axis (c in the tetragonal and hexagonal systems, b for monoclinic crystals).

In case of simple crystals, often encountered in the study of the less soluble compounds, the crystal is set up in accordance with habit, the axis of greatest extension being selected as the c - axis, and the best developed pair of faces as intersecting the b - axis only. This is at variance with the recommendation of the Armour Research Foundation<sup>(6)</sup> that "in no case will the choice of crystallographic

axes be based on crystal habit," but is founded on the law of Bravais which states that best developed faces conform to lattice planes with greatest interplanar spacing. It follows as a corollary that best developed zones in a crystal correspond to lattice lines of greatest point density, which brings the convention adopted into harmony with the extended Naumann rule ( $c < a < b$ ). In the absence of X-ray structural data and in cases of form underdevelopment this appears to be the only basis for orienting crystals.

In cases of more complete development of crystal forms the principle of simplest indices and Barker's rules<sup>(9)</sup> as modified by Terpstra, Donnay, Melon and Van Weerden<sup>(10)</sup> are generally followed in setting up crystals. An exception may be afforded by a crystal which is evidently pseudo-symmetric and which is oriented conformable to conventions applicable to the higher symmetry class from which it may be thought of as derived by a small homogeneous transformation.

2 c. Crystal Habit is described as equant, tabular or platy, prismatic or acicular, and bladed. When possible this is followed by the listing of observed crystal forms. Observations on twinning, cleavage, striations and other growth accessories are included in this section.

The customary conventions are followed in the use of Miller symbols which are enclosed in parenthesis to designate a crystal face  $(h k l)$ , in braces or curly brackets to indicate a crystal form or set of equivalent faces  $\{h k l\}$ . Square brackets are used to designate a zone axis  $[u v w]$ , and carets for a set of equivalent zone axes  $\langle u v w \rangle$ . Unenclosed Miller indices are used in crystal drawings. Any angle designations between faces such as  $(h k l) \wedge (H K L)$  refer to polar angles, i.e. to angles between face normals.

Letter notations for crystal forms follow the Barker conventions and in most cases conform to general usage: a  $\{100\}$ , b  $\{010\}$ , c  $\{001\}$ , m  $\{110\}$ , M  $\{1\bar{1}0\}$ , r  $\{101\}$ , R  $\{1\bar{0}1\}$ , q  $\{011\}$ , Q  $\{0\bar{1}1\}$ , o  $\{111\}$ , O  $\{1\bar{1}1\}$ , p  $\{1\bar{1}\bar{1}\}$ , P  $\{\bar{1}\bar{1}\bar{1}\}$ .

### 3. Optical Properties.

3 a. Optical Character is designated as isotropic, uniaxial positive, uniaxial negative, biaxial positive or biaxial negative.

3 b. Optic Axial Angle is measured in the crystal and is designated by  $2V$ . Unless otherwise stated its value is determined for sodium light (5893A). Its magnitude is either estimated in which case it is followed by the notation "(estimated)," calculated from the indices of refraction,

which is expressed by "(calculated)," or measured directly on the universal stage or by Mallard's method, this being designated by "(measured)."

3 c. Optic Orientation: X, Y and Z are used to express the vibration directions corresponding to the low, intermediate and high principal indices of biaxial crystals. Their relation to the crystal axes is noted. For monoclinic crystals  $X \wedge c = \psi$  signifies that the X axis of the indicatrix makes an angle  $\psi$  with the crystallographic  $c$  - axis. In the triclinic system the orientation of the indicatrix is given by angular coordinates (polar  $\rho$  and azimuthal  $\phi$ ) of the directions of X, Y and Z on the stereographic projection of the crystal in conventional orientation. When available data do not permit orientation of the indicatrix, extinction angles to prominent crystal edges on commonly occurring faces are recorded.

In uniaxial crystals O and E refer respectively to vibration directions of the ordinary and extraordinary ray.

3 d. Dispersion of optic axes is expressed as  $v > r$  (optic angle greater for violet light than for red light) or  $r > v$ , and is further qualified by adjectives: perceptible, distinct, strong or extreme. Dispersion of bisectrices (crossed, inclined or horizontal), crossed dispersion of the axial plane,

abnormal interference colors are also noted in this section.

3 e. Indices of Refraction, unless otherwise stated, have been determined by the Becke method using sodium light (5893A), and with a degree of accuracy believed to be of the order of one or two units in the third decimal place. If, due to the small size of crystals, their hygroscopic nature or other unfavorable circumstances, this degree of accuracy could not be reached the estimated limits of error are stated.

In uniaxial crystals  $N_o$  and  $N_e$  refer respectively to indices of refraction of the ordinary and extraordinary ray. For biaxial crystals refractive indices corresponding to the X, Y and Z direction have been designated by symbols  $N_p$ ,  $N_m$  and  $N_g$ . When thought advisable indices corresponding to prominent crystallographic directions or to extinction positions on prominent faces are also given. The above choice of symbols conform to the usage of A. N. Winchell in his three monumental compilations of data on optical properties of minerals and artificial compounds<sup>(3),(11),(12)</sup>, but is contrary to recommendations of the Mineralogical Society of America<sup>(13)</sup> and of the Armour Research Foundation<sup>(6)</sup>, both of these bodies adopting the symbols  $\alpha$ ,  $\beta$  and  $\gamma$  for refractive indices of biaxial crystals,  $\omega$  and  $\epsilon$  for uniaxial crystals. It may be noted in this connection that the editors

of the new edition of Dana's "System of Mineralogy"<sup>(14)</sup> also have not followed this recommended usage "largely for typographical reasons and because the Greek letters  $\alpha$ ,  $\beta$  and  $\gamma$  are much overworked as designations for physical constants." Unfortunately, the admirable system adopted in Dana which avoids any special notation for the different indices is not well adapted for presentation of fragmental data. Symbols  $n_\alpha$ ,  $n_\beta$  and  $n_\gamma$  used by Von Groth and some other authors is not apt to lead to confusion with crystallographic notations but were rejected for typographical reasons.

3 f. Color of the compound in bulk, in reflected or transmitted light, with observations on pleochroism and absorption formulae. When available, observations on absorption spectra of crystals are also included.

✓ 1. Plutonium (IV) Dioxide. PuO<sub>2</sub>.

Prepared by ignition of the metal.

Crystal Morphology: Isometric. The X-ray structure of this compound has been worked out by Zachariasen<sup>(17)</sup>, (pp. 7-8).

The sample examined consisted of anhedral grains.

Optical Properties: Isotropic or weakly birefringent (due to strain?). Refractive indices: N(5893A) = 2.402; N(6708A) = 2.350 ± 0.005. Color of streak yellow, green in transmitted light.



X 2. Plutonium (IV) Peroxide. PuO<sub>3</sub>.

Two types of plutonium peroxides are recognized from X-ray diffraction studies and their behavior in precipitation (15,16).

The references consulted are not in agreement as to the conditions controlling the formation of the two types of peroxides.

Plutonium peroxide was precipitated with excess H<sub>2</sub>O<sub>2</sub> from 1 M HCl, 3 M HNO<sub>3</sub>, 0.125 M and 0.25 M H<sub>2</sub>SO<sub>4</sub>. These precipitates were undistinguishable under the microscope, though the poor crystal development and small size of individuals, rarely exceeding one micron, made it impossible to obtain more than fragmentary data on optical properties. Peroxide precipitates formed in 0.5 M, 1 M and 2 M H<sub>2</sub>SO<sub>4</sub> consisted predominantly of the same phase as far as could be ascertained under the microscope, but contained, in addition, crystals described under (3).

Morphology: Anhedral granules. The larger particles exhibited a tendency towards prismatic development.

Optical Properties: Weak birefringence observed only on the larger particles, which were further characterized by direct extinction and positive elongation. Mean refractive index 1.70. Color emerald green.

X 3. Plutonium (IV) Peroxide Sulfate (?).

Samples of peroxide precipitated from sulfuric acid solutions of concentrations exceeding  $0.5 \text{ M H}_2\text{SO}_4$  contained in addition to the normal peroxide described under (2) thin scales of what may be plutonium peroxide sulfate. The relative amount of this phase increased with increasing acid concentration and, up to a certain point, with the time of digestion. The plates appeared to have been formed by aggregation and assimilation of granules of the normal peroxide which were at times observed as inclusions along the edge of a plate. Unlike the normal peroxide these crystals were not stable on washing, breaking up into flocs or aggregates of granules such as described under (2).

Morphology: Thin plates with irregular outlines and a scaly structure.

Optical Properties: Biaxial negative with a very small optic angle ( $2V=5^\circ$ , estimated). The acute bisectrix is normal to the plates. Refractive index:  $N_g$  sensibly equal to  $N_m=1.585\pm 0.005$ .

J 4. Plutonium (III) Tri-Fluoride.  $\text{PuF}_3$ .

A sample of this compound was supplied by Group CMR-11.

Crystal Morphology: Known to crystallize in the hexagonal

system from X-ray diffraction studies<sup>(17)</sup>, (pp. 11-12).

The sample examined consisted of anhedral grains and fibrous aggregates without developed crystal faces. The individual crystals comprising the aggregates were elongated parallel to the c - axis.

Optical Properties: Uniaxial positive. Refractive indices:  
No = 1.684; Ne = 1.685. Color blue, not noticeably pleochroic.

✓ 5. Plutonium (IV) Tetra-Fluoride. PuF<sub>4</sub>.

d A sample of this compound was supplied by Group CMR-11.

Crystal Morphology: Known to be monoclinic from X-ray diffraction studies<sup>(17)</sup>, (pp. 12,13). The sample examined consisted of extremely finegrained unoriented aggregates.

Optical Properties: Because of the fine size of the individual crystals only the mean index of refraction could be determined: Nm = 1.595. Color reddish brown.

X 6. Plutonyl Di-Chloride Hydrate. PuO<sub>2</sub>Cl<sub>2</sub> · x H<sub>2</sub>O.

Prepared by repeated evaporation of a Pu (VI) nitrate solution to dryness with hydrochloric acid. The above formula has been assigned to this compound by Cunningham<sup>(7)</sup>, (p.53). It is, however, possible that an acid salt analogous to UO<sub>2</sub>Cl<sub>2</sub>·HCl·2 H<sub>2</sub>O is formed under these conditions.

Crystal Morphology: Orthorhombic. Prismatic or bladed, elongated along  $[001]$ , flattened on  $\{010\}$ . Dendritic growths common.

Optical Properties: Biaxial negative with  $2V = 40^\circ$  (estimated). Optic orientation:  $X = \underline{a}$ ,  $Y = \underline{b}$ ,  $Z = \underline{c}$ . Dispersion of optic axes  $r > v$  weak. Refractive indices:  $N_g = 1.700$ ;  $N_m = 1.684$ ;  $N_p = 1.650$ . Color in bulk amber. Strongly pleochroic with  $X =$  very pale pink,  $Y =$  yellow,  $Z =$  greenish yellow.

✓ 7. Di-Cesium Plutonium (IV) Hexa-Chloride.  $Cs_2PuCl_6$ .

Prepared according to Anderson<sup>(18)</sup> by spontaneous evaporation of a solution containing 160 g.p.l. Cs and 40 g.p.l. Pu (IV) in 1 M HCl. The crystals were washed twice with ethanol and, finally, with acetone. Anderson<sup>(18)</sup> regards this compound as a salt of chloroplutonic acid:  $H_2PuCl_6$ .

Crystal Morphology: Rhombohedral. The X-ray structure has been worked out by Zachariasen<sup>(19)</sup>. Crystal habit: Basal plates with hexagonal outline and perfect basal cleavage. (Figure 10).

Optical Properties: Uniaxial negative; in part anomalously biaxial with the optic axial angle varying from a few degrees to  $22^\circ$ . Single plates exhibited irregular biaxial

areas with axial planes at right angles and separated by a uniaxial zone. Refractive indices:  $n_o = 1.728 \pm 0.003$ ,  $n_e = 1.699$ . Color greenish-yellow in bulk and by transmitted light. Not noticeably pleochroic.

8. Ammonium Plutonyl Tri-Nitrate.  $NH_4 \cdot PuO_2(NO_3)_3$ .

Prepared by oxidizing a solution of Pu (IV) in nitric acid, with  $KMnO_4$ , making the solution 8 M in  $NH_4NO_3$  and 2 M in  $HNO_3$ , extracting with diethyl ether, separating the ether layer and allowing it to evaporate over water. After evaporating the aqueous solution to dryness, the residue was taken up with water and the compound recrystallized from the resulting solution which was orange-pink in color. Cunningham<sup>(7)</sup>, pp. 40-41) describes the salt formed in the above manner as plutonium di-oxy di-nitrate, giving "method of preparation" as the basis for this identification. He notes, however, that "probably a considerable amount of both  $NH_4NO_3$  and  $HNO_3$  were carried over from the initial extraction." The salt obtained was not isomorphous with either  $UO_2(NO_3)_2 \cdot 6 H_2O$ ,  $UO_2(NO_3)_2 \cdot 3 H_2O$  or  $UO_2(NO_3)_2 \cdot 2 H_2O$  but was isomorphous with ammonium uranyl tri-nitrate,  $NH_4 \cdot UO_2(NO_3)_3$ . Furthermore, the compound gave a strong microchemical test for ammonium with chloroplatinic acid.

Crystal Morphology: Rhombohedral with  $\alpha = 96^\circ$ . Crystal habit is equant by equal development of r {100}, a {101} and

a  $\{110\}$ , the latter form striated parallel to the edge  $\langle 100 \rangle$  (Figure 1). Subordinate forms observed were o  $\{11\bar{1}\}$ , c  $\{111\}$  and  $\{201\}$ . Dendritic growths common.

Optical Properties: Uniaxial negative. Refractive indices:  $N_o = 1.649$ ;  $N_e = 1.488$ . Color in bulk orange-brown. In transmitted light strikingly pleochroic with O = green, E = pink.

9. Di-Ammonium Plutonium (IV) Hexa-Nitrate.  $(NH_4)_2Pu(NO_3)_6$ .

Prepared by evaporating spontaneously a 1 M  $HNO_3$  solution containing  $(NH_4)_2$  and Pu (IV) in stoichiometric proportion<sup>(7)</sup>, (p.96). This salt belongs to a group of isomorphous compounds which also includes double nitrates of plutonium with potassium (10), rubidium (11) and thallium (12), as well as  $(NH_4)_2Ce(NO_3)_6$  and  $K_2Ce(NO_3)_6$  which are listed by Groth<sup>(20)</sup>, (Vol. II, pp. 159-161). The corresponding double salt of plutonium with sodium could not be obtained, sodium nitrate crystallizing from nitric acid solutions of Pu (IV) and Na. The plutonium nitrate remaining dries to a plastic non-crystalline mass.

Crystal Morphology: Monoclinic, domatic (class  $\overline{2}$  or  $C_2$ ).

Groth lists the corresponding cerium salt as monoclinic, pyramidal. Elements:  $a:b:c = 1.87:1:1.15$ ;  $\beta$  near  $90^\circ$ .

$[\bar{1}01] \wedge [101] = 63^\circ$ ,  $[11\bar{1}] \wedge [1\bar{1}1] = 49^\circ$ . Crystal habit tabular,

flattened on  $b \{010\}$  or prismatic, elongated along  $[10\bar{1}]$ . Common forms besides  $b$  are  $r \{101\}$ ,  $r_1 \{\bar{1}0\bar{1}\}$ ,  $R \{\bar{1}01\}$ ,  $R_1 \{10\bar{1}\}$ ,  $a \{100\}$  and  $m \{110\}$  (Figure 2). The complimentary forms  $a_1 \{\bar{1}00\}$  and  $m_1 \{\bar{1}\bar{1}0\}$  are occasionally developed in crystals of outwardly holohedral appearance. Twinning, simple or repeated, common on  $\{101\}$  and  $\{10\bar{1}\}$ . The most usual appearance of crystals is that of roughly hexagonal plates flattened on common  $b \{010\}$ , twinned polysynthetically, with three sets of interpenetrating lamellae (Figure 12,13).

Optical Properties: Biaxial positive with  $2V = 55^\circ$  (estimated). Optic orientation:  $Z = \underline{b}$ ,  $X \wedge c = 81^\circ$ . Dispersion of optic axes  $v > r$  distinct. Strong crossed dispersion of the bisectrices  $X_r \wedge [001] > X_v \wedge [001]$ , as a result of which plates normal to  $Z$  exhibit anomalous interference colors: ultra-blue as the position of maximum extinction in white light is approached from one side, and olive-green on approaching extinction from the other side. Refractive indices:  $N_g = 1.663$ ;  $N_m = 1.639$ ;  $N_p = 1.633$ . Color pale green with absorption  $Z > Y > X$ .

✓ 10. Di-Potassium Plutonium (IV) Hexa-Nitrate.  $K_2Pu(NO_3)_6$ .

Prepared by evaporating spontaneously a 1 M  $HNO_3$  solution containing  $K_2$  and Pu (IV) in stoichiometric proportion.

The compound is isomorphous with  $(\text{NH}_4)_2\text{Pu}(\text{NO}_3)_6$  (9).

Crystal Morphology: Monoclinic, domatic. Similar in habit to di-ammonium plutonium hexa-nitrate.

Optical Properties: Biaxial positive with  $2V = 56^\circ$  (estimated). Axial plane and Z are normal to the symmetry plane. Distinct dispersion of optic axes  $v > r$ , and strong crossed dispersion of the bisectrices. Refractive indices:  $N_g = 1.658$ ;  $N_m = 1.633$ ;  $N_p = 1.625$ . Color pale green with absorption:  $Z > Y > X$ .

11. Di-Rubidium Plutonium (IV) Hexa-Nitrate.  $\text{Rb}_2\text{Pu}(\text{NO}_3)_6$ .

Prepared by evaporating spontaneously a 1 M  $\text{HNO}_3$  solution containing  $\text{Rb}_2$  and Pu (IV) in stoichiometric proportion.

The compound is isomorphous with  $(\text{NH}_4)_2\text{Pu}(\text{NO}_3)_6$  (9).

Crystal Morphology: Monoclinic, domatic. Similar in habit to di-ammonium plutonium hexa-nitrate.

Optical Properties: Biaxial positive with  $2V = 60^\circ$  (estimated). Axial plane and Z are normal to the symmetry plane. Distinct dispersion of optic axes  $v > r$ , and strong crossed dispersion of the bisectrices. Refractive indices:  $N_g = 1.660$ ;  $N_m = 1.630 \pm 0.003$ ;  $N_p = 1.621$ . Color pale green with absorption  $Z > Y > X$ .



✓ 12. Di-Thallos Plutonium (IV) Hexa-Nitrate.  $Tl_2Pu(NO_3)_6$ .

Prepared by evaporating spontaneously a 1 M  $HNO_3$  solution containing  $Tl_2$  and Pu in stoichiometric proportion. The compound is isomorphous with  $(NH_4)_2Pu(NO_3)_6$  (9).

Crystal Morphology: Monoclinic, domatic. Similar in habit to di-ammonium plutonium hexa-nitrate.

Optical Properties: Biaxial positive with  $2V = 60^\circ$

(measured). Axial plane and Z are normal to the symmetry plane. Distinct dispersion of optic axes  $v > r$  and strong crossed dispersion of the bisectrices giving rise to striking anomalous interference colors. Refractive indices:

$N_g = 1.735 \pm 0.004$ ;  $N_m = 1.721 \pm 0.004$ ;  $N_p = 1.716 \pm 0.004$ .

Color light green with absorption  $Z > Y > X$ .

✓ 13. Di-Cesium Plutonium (IV) Hexa-Nitrate.  $Cs_2Pu(NO_3)_6$ .

Prepared by evaporating spontaneously a 1 M  $HNO_3$  solution containing  $Cs_2$  and Pu in stoichiometric proportion. It is not certain that this salt belongs to the isomorphous series represented by  $(NH_4)_2Pu(NO_3)_6$  (9).

Crystal Morphology: Monoclinic. No evidence of hemihedral development was observed. Unlike the other double nitrates of plutonium with alkali this salt does not form polysynthetic twins but occurs as pseudo-hexagonal plates, flattened on

b {010}, which are cyclic penetration trillings with opposite sextants extinguishing alike.

Optical Properties: Biaxial positive with a small optic angle,  $2V = 15^\circ$  (estimated). The axial plane and Z are normal to the symmetry plane. No perceptible dispersion of bisectrices or of optic axes. Refractive indices:  $N_g = 1.657$ ;  $N_m = 1.621$ ;  $N_p = 1.620$ . Color light green.

14. Magnesium Plutonium (IV) Hexa-Nitrate Octo-Hydrate.

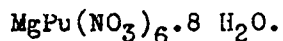

Prepared by evaporating spontaneously a 1 M  $HNO_3$  solution containing Mg and Pu in stoichiometric proportion. This compound is a member of a group of isomorphous salts, which also includes double nitrates of plutonium with zinc, cobalt, nickel, as well as the salts  $MgCe(NO_3)_6 \cdot 8 H_2O$ ,  $ZnCe(NO_3)_6 \cdot 8 H_2O$ ,  $MgTh(NO_3)_6 \cdot 8 H_2O$ ,  $ZnTh(NO_3)_6 \cdot 8 H_2O$ ,  $NiTh(NO_3)_6 \cdot 8 H_2O$ <sup>(20)</sup> (vol. II, pp. 161-163).

Crystal Morphology: Monoclinic, tabular on c {001} with p {111}, a {100} and o {111} (Figure 3, 11).  $[110] \wedge [11\bar{0}] = 92^\circ$ .

Optical Properties: Biaxial negative with  $2V = 30^\circ$  (estimated). Optic orientation:  $Z = [010]$ , X is sensibly

normal to  $c$   $\{001\}$ . Dispersion of optic axes  $v > r$ , strong.  
 Refractive indices:  $N_g = 1.554$ ;  $N_m = 1.553$ ;  $N_p = 1.538$ .  
 Color in bulk green, in transmitted light nearly colorless.

✓ 15. Zinc Plutonium (IV) Hexa-Nitrate Octo-Hydrate.

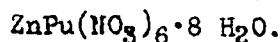

Prepared by spontaneous evaporation of a 1 M  $HNO_3$  solution containing Zn and Pu (IV) in stoichiometric proportion. Isomorphous with magnesium plutonium hexa-nitrate octo-hydrate (14).

Crystal Morphology: Monoclinic. Similar in habit to  $MgPu(NO_3)_6 \cdot 8 H_2O$ .

Optical Properties: Biaxial negative with  $2V = 25^\circ$  (measured).  $Z = [010]$ ,  $X$  is sensibly normal to  $c$   $\{001\}$ . Dispersion of optic axes  $v > r$  strong. Refractive indices:  $N_g = 1.570$ ;  $N_m = 1.568$ ;  $N_p = 1.550$ . Color in bulk green, nearly colorless in transmitted light.

✓ 16. Cobalt Plutonium (IV) Hexa-Nitrate Octo-Hydrate.

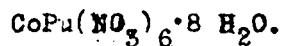

Prepared by spontaneous evaporation of a 1 M  $HNO_3$  solution containing Co and Pu (IV) in stoichiometric proportion. Insomorphous with magnesium plutonium hexa-nitrate (14).

Crystal Morphology: Monoclinic. Similar in habit to  
 $\text{MgPu}(\text{NO}_3)_6 \cdot 8 \text{H}_2\text{O}$ .

Optical Properties: Biaxial negative with  $2V = 20^\circ$   
 (estimated).  $Z = [010]$ ,  $X$  is sensibly normal to  $c \{001\}$ .  
 Moderate dispersion of optic axes  $v > r$ . Refractive indices:  
 $N_g = 1.568$ ;  $N_m = 1.567$ ;  $N_p = 1.550 \pm 0.004$ . Color: faint  
 pink in transmitted light.

✓ 17. Nickel Plutonium (IV) Hexa-Nitrate Octo-Hydrate.

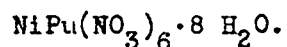

Prepared by spontaneous evaporation of a 1 M  $\text{HNO}_3$  solution  
 containing Ni and Pu (IV) in stoichiometric proportion.

Isomorphous with magnesium plutonium hexa-nitrate octo-  
 hydrate (14).

Crystal Morphology: Monoclinic. Similar in habit to  
 $\text{Mg Pu}(\text{NO}_3)_6 \cdot 8 \text{H}_2\text{O}$ .

Optical Properties: Biaxial negative with  $2V = 10^\circ$   
 (estimated). Optic orientation:  $Z = [010]$ ,  $X$  is sensibly  
 normal to  $c \{001\}$ . Strong dispersion of optic axes  $v > r$ .  
 Refractive indices:  $N_g$  and  $N_m = 1.576$ ;  $N_p = 1.550 \pm 0.005$ .  
 Color in bulk green, nearly colorless in transmitted light.

X 18. Di-Plutonium (III) Tri-Sulfate Hepta (?) Hydrate.

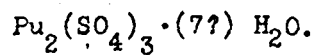

Prepared by a procedure according to L. B. Asprey<sup>(21)</sup>, (p.17).

A solution of  $\text{Pu}(\text{SO}_4)_2$  was reduced with hydroxylamine and diluted with methyl alcohol. Final conditions: Pu 23 g.p.l.;  $\text{H}_2\text{SO}_4$  0.3 M;  $\text{CH}_3\text{OH}$  50% by volume. Crystallization was slow, continuing over a period of two days. The crystals were washed with 75% methyl alcohol.

Crystal Morphology: Orthorhombic. Crystal habit prismatic to acicular elongated along [001], usually terminated by the base, occasionally by q {011}. Imperfect basal cleavage.

Optical Properties: Biaxial negative with  $2V = 30^\circ$ .

(estimated). Optic orientation:  $X = \underline{c}$ ,  $Y = \underline{b}$ ,  $Z = \underline{a}$ .

Refractive indices:  $N_g = 1.620$ ;  $N_m = 1.618$ ;  $N_p = 1.591$ .

Color in bulk lavender, in transmitted light pale purplish blue without perceptible pleochroism.

X 19. Plutonium (III) Sulfate (?) Triclinic Form.

Some triclinic crystals were observed on wet slides in the course of preparing the orthorhombic di-plutonium trisulfate.

During drying the triclinic crystals changed to the orthorhombic form. (20) By washing the crystals in absolute alcohol and drying in vacuo or over methyl alcohol it was possible to obtain the triclinic form exclusively. By introducing water vapor into the chamber during drying a rapid change to the orthorhombic form could be induced at will (Figure 14,15). The composition of this compound is problematical. From the method of preparation and stability relations one would assume it to be a lower hydrate of  $\text{Pu}_2(\text{SO}_4)_3$  than the orthorhombic modification. On the other hand, the indices of refraction of the triclinic crystals are appreciably lower than the indices of the orthorhombic hepta (?) hydrate, while ordinarily decrease in the water of hydration of a compound is accompanied by a rise in the refractive index.

Crystal Morphology: Triclinic. Crystal habit: Tabular, bounded by three pinacoids. Typical rhomb-shaped plates are characterized by a vertex angle of  $69^\circ$ .

Optical Properties: Biaxial negative. Typical plates give an uncentered interference figure and extinction for the slow ray inclined  $18^\circ$  to one edge in the acute angle.

Refractive indices corresponding to the two extinction positions of a typical plate are 1.591 and 1.569. Color grayish blue. Crystals gave an absorption spectrum characteristic of trivalent plutonium.

✓  
20. Plutonium (IV) Di-Sulfate Tetra-Hydrate.  $\text{Pu}(\text{SO}_4)_2 \cdot 4 \text{H}_2\text{O}$ .

Prepared according to H. H. Anderson<sup>(21)</sup> (p.27) by diluting with methyl alcohol a solution of plutonium (IV) sulfate in sulfuric acid. Final conditions: Pu 20 g.p.l.,  $\text{H}_2\text{SO}_4$  2.75 M,  $\text{CH}_3\text{OH}$  46% by volume. The compound is isomorphous with  $\text{Zr}(\text{SO}_4)_2 \cdot 4 \text{H}_2\text{O}$ ,  $\text{Ce}(\text{SO}_4)_2 \cdot 4 \text{H}_2\text{O}$  and  $\text{U}(\text{SO}_4)_2 \cdot 4 \text{H}_2\text{O}$ .

Ref  
Crystal Morphology: Orthorhombic. Axial ratio  $\underline{c} : \underline{a} = 0.65$ . Angle  $[\underline{101}] \wedge [\underline{001}] = 57^\circ$ . Crystal habit: Blades flattened on  $\{\underline{010}\}$ , elongated parallel to  $[\underline{001}]$ . Observed forms were the three pinacoids and the macrodome  $r \{\underline{101}\}$ . Forms radial aggregates. (Figure 16).

Optical Properties: Biaxial negative.  $2V = 84^\circ$  (calculated).  
Optic orientation:  $X = \underline{c}$ ,  $Y = \underline{b}$ ,  $Z = \underline{a}$ . Refractive indices:  $N_g = 1.685$ ;  $N_m = 1.644$ ;  $N_p = 1.597$ . Color: in bulk coral pink, in transmitted polarized light strongly pleochroic with  $X = \text{pink}$ ,  $Y = \text{brownish yellow}$ ,  $Z = \text{green}$ .

The absorption spectrum of this compound shows marked variations for light vibrating in different directions.

## Absorption Bands (millimicrons):

<u>For Light Vibrating in the Z Direction</u>	<u>For Light Vibrating in the X Direction</u>
453 - weak, wide	
468 - weak, wide	
480 - weak, wide	
498 - medium, wide	490 - strong, narrow
523 - medium, wide	514 - strong, narrow
	525 - weak, narrow
551 - medium, very wide	544 - strong, narrow
577 - strong, narrow	
653 - strong, degraded to violet	650 - weak
675 - strong, narrow	675 - medium, narrow
690 - narrow	

Dissappearance of band 577, weakening of the red bands 675, 653, strengthening, narrowing and shift to violet of bands 551, 498, and splitting of the band at 523 into two bands at 525 and 514 are the most striking effects on the spectrum as the vibration direction of light is changed from coincidence with Z to that with X.

21. Di-Ammonium Di-Plutonyl Tri-Sulfate Penta-Hydrate.

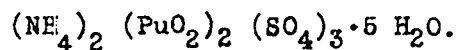

Prepared by treating  $\text{NH}_4\text{PuO}_2 (\text{NO}_3)_2$  with sulfuric acid.

The compound is isomorphous with  $(\text{NH}_4)_2(\text{UO}_2)_2(\text{SO}_4)_3 \cdot 5 \text{H}_2\text{O}$ .

Crystal Morphology: Orthorhombic with  $a : b : c = 1.0 : 1 : 0.91$ ;

$(101) \wedge (\bar{1}01) = 85^\circ$ ;  $[\bar{1}11] \wedge [\bar{1}\bar{1}1] = 73^\circ$ . Crystal habit: Tab-

ular on  $b \{010\}$  with  $r \{101\}$ ,  $m \{110\}$  and  $c \{001\}$ .



Optical Properties: Biaxial negative with  $2V = 25^\circ$

(estimated). Optic orientation:  $X = \underline{b}$ ,  $Y = \underline{c}$ ,  $Z = \underline{a}$ .

Perceptible dispersion of optic axes  $v > r$ . Refractive indices  $N_g = 1.591$ ;  $N_m = 1.589$ ;  $N_p = 1.565 \pm 0.004$ . Color yellow with absorption  $Z = Y > X$ .

✓ 22. Sodium Plutonyl Tri-Acetate.  $NaPuO_2(C_2H_3O_2)_3$ .

Prepared by the method recommended by Chamot and Mason<sup>(22)</sup>

(p.51) for crystallizing sodium uranyl tri-acetate with which this compound is isomorphous.

Crystal Morphology: Isometric, tetartoidal (class T or 23)

The X-ray structure is given by Zachariasen<sup>(17)</sup> (p.25).

Crystal habit: Equant, tetrahedrons and cubes.

Optical Properties: Isotropic. Refractive index 1.518.

The crystals are soluble in some immersion oils, including "Shillaber's Index of Refraction Liquids", but are stable in mixtures of "Nujol" and alpha-mono-chloro-naphthalene which were used to determine the index. Color pink.

*CS-1068 (A-158) p 4 (1943)  
Kennedy: No NaPuO<sub>2</sub>Cl<sub>3</sub> 1.5993  
No NaPuO<sub>2</sub>Ac<sub>3</sub> 1.5110*

✓ 23. Sodium Zinc Tri-Plutonyl Nono-Acetate Hexa-Hydrate.

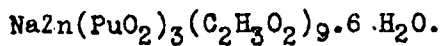

Prepared by the method recommended by Chamot and Mason<sup>(22)</sup>

(p.56) for crystallizing the corresponding uranyl salt with

which this compound is isomorphous.

Crystal Morphology: Monoclinic. Simple crystals are prismatic, elongated along  $[010]$  with a  $\{100\}$ ,  $c\{001\}$  and  $o.\{111\}$  as dominant forms. Commonly occurs as simple or repeated twins with  $m\{110\}$  as the twinning plane. The twins present a pseudo-octahedral appearance. A simple twin is sketched on Figure 4.

Optical Properties: Biaxial. The optic plane and  $Z$  are normal to  $b\{010\}$ . Refractive indices:  $N_g = 1.490$ ;  $N_p = 1.486$ . Color pink.

24. Di-Plutonium (III) Tri-Oxalate Nono (?) Hydrate.

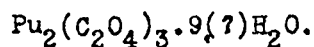

*change*  
Prepared by cooling to room temperature a solution saturated with respect to plutonium trioxalate at  $70^\circ\text{C}$ .

Crystal Morphology: Monoclinic.  $\beta = 114^\circ$ ,  $[110] \wedge [\bar{1}\bar{1}0] = 87^\circ$ . Crystal habit: Blades flattened on  $\{001\}$  and elongated along  $[100]$ . Forms observed beside the base were  $b\{010\}$  and  $m\{110\}$ , (Figure 17). The compound is isomorphous with "didymium" oxalate listed by Groth<sup>(20)</sup> (Vol. III, p. 153).

Optical Properties: Biaxial negative with  $2V = 78^\circ$  (calculated). Optic orientation:  $X = b$ ,  $Y \wedge [100] = 26^\circ$  in

the acute angle  $\beta$ . Refractive indices:  $N_g = 1.636$ ;  
 $N_m = 1.579$ ;  $N_p = 1.502$ .  $N_a$  parallel to  $[100]$  is 1.590.  
 Color: dark green in bulk, grass green to nearly colorless  
 in transmitted light with absorption  $Z > Y > X$ .

✓  
 25. Plutonium (III) Oxalato-Chloride.

*change*  
 This compound was identified in a sample of solids reprecipitating from a solution of plutonium oxalate in hydrochloric acid. It is slowly soluble in 6 M HCl. Slowly decomposed by water yielding aggregates of minute crystals of  $Pu_2(C_2O_4)_3 \cdot 9 H_2O$  and a solution which gave a strong test for the chloride ion.

Crystal Morphology: Orthorhombic, prismatic to acicular, elongated along  $[001]$ , with  $a \{110\}$  and  $b \{010\}$ .  
 (Figure 20).

Optical Properties: Biaxial negative.  $Z$  is parallel to the elongation,  $Y = \underline{b}$ . Color blue, non-pleochroic. Absorption spectrum characteristic of trivalent plutonium with bands at 5700, 6060 and 6700A.

26. Plutonium (IV) Di-Oxalate Hexa-Hydrate.  $Pu(C_2O_4)_2 \cdot 6 H_2O$ .

Prepared by the reaction of oxalic acid with plutonium (IV) in a hydrochloric acid solution. Final conditions: Pu 1.3

g.p.l.,  $\text{H}_2\text{C}_2\text{O}_4$  212 g.p.l.,  $\text{HCl}$  0.75 M. The compound is isomorphous with  $\text{U}(\text{C}_2\text{O}_4)_2 \cdot 6 \text{H}_2\text{O}$ .

Crystal Morphology: Orthorhombic. Ratio c: a approximately 0.5. Crystal habit: Observed as blades, flattened on  $\{010\}$ , elongated along  $[001]$ , terminated by  $\{201\}$ , forming cruciform penetration twins with  $\{201\}$  as the twinning plane (Figure 5a). Usually pseudo-tetragonal by mimetic twinning, forming plates with square (Figure 5b) or octagonal (Figure 5c) outline, the latter by development of termination  $\{101\}$  instead of  $\{201\}$ . (Figures 18,19).

Optical Properties: Biaxial negative with small optic angle ( $2V$  estimated  $5^\circ$ ). Optic orientation:  $X = \underline{b}$ ,  $Y = \underline{a}$ ,  $Z = \underline{c}$ . Refractive indices:  $n_g$  sensibly equal to  $n_m = 1.628$ ;  $n_p = 1.523$ . Color pistachio green in bulk, yellowish green in transmitted light.

27. Plutonyl Oxalate Tri-Hydrate.  $\text{PuO}_2\text{C}_2\text{O}_4 \cdot 3 \text{H}_2\text{O}$ .

Prepared according to Cunningham<sup>(7)</sup> (p.74) by adding oxalic acid to a concentrated solution of plutonyl nitrate. According to Katzin<sup>(23)</sup> (p.25) oxalic acid reduced hexavalent plutonium to Pu (IV). However, the identity of the precipitate as a salt of Pu (VI) was established by the study of the absorption spectrum of the solid. The compound is

probably isomorphous with uranyl oxalate,  $\text{UO}_2 \cdot \text{C}_2\text{O}_4 \cdot 3 \text{H}_2\text{O}$ .

Crystal Morphology: Probably monoclinic. Crystal habit: nearly square plates tabular on  $b \{010\}$ .

Optical Properties: Biaxial positive with  $2V = 50^\circ$  (estimated). Optic orientation:  $Y = \underline{b}$ , extinction sensibly parallel to the edges of plates. Refractive indices:  $N_g = 1.620$ ;  $N_m = 1.520$ ;  $N_p = 1.498$ . Color in bulk tan. Pleochroic with  $Z = \text{green}$ ,  $Y$  and  $X = \text{pink}$ . Absorption spectrum of the solid in bulk:

<u>Wave length,</u> <u>Millimicrons</u>	<u>Band</u> <u>Intensity</u>
468 - 486	medium (wide)
508	strong (narrow)
517.5	weak (narrow)
520 - 533	medium (wide)
546	weak (narrow)
560	medium (narrow)
570	very weak (narrow)
584	weak (narrow)
593	weak (narrow)
604	medium (narrow)
633.5	strong (narrow)
848	very strong (narrow)

28. Bismuth (III) Plutonium (IV) Oxalate.  $\text{PuBiH}(\text{C}_2\text{O}_4)_4 \cdot 9 \text{H}_2\text{O}$ .

Prepared according to J. W. Hamaker and C. W. Koch, as abstracted by Cunningham<sup>(7)</sup> (pp.83-84), by precipitation with oxalic acid from  $1M$ ,  $2M$ , and  $4M$   $\text{HNO}_3$  solutions containing Pu (IV) and Bi in stoichiometric proportion.

Crystal Morphology: Tetragonal. Crystal habit: Prismatic when precipitated from 1 and 2 M  $\text{HNO}_3$ , square basal plates when grown in 4 M acid.

Optical Properties: Uniaxial negative, Refractive indices:  $N_o = 1.646$ ;  $N_e = 1.51 \pm 0.01$ . Color in bulk tan, in transmitted light strongly pleochroic with O = green, E = pink.

29. Plutonium (III) Succinate.

Prepared by adding succinic acid to a hydrochloric acid solution of Pu (III) and reducing excess acidity with ammonia.

Crystal morphology: Monoclinic. Occurs as blades, flattened on c  $\{001\}$ , elongated parallel to  $[100]$ . Terminations usually ragged, occasionally m  $\{110\}$ . Often forms stellar aggregates.

Optical Properties: Biaxial positive with  $2V = 32^\circ$  (calculated). Optic orientation: X = b,  $Z \wedge [100] = 18^\circ$ . Refractive indices:  $N_g = 1.65 \pm 0.004$ ;  $N_m = 1.568$ ;  $N_p = 1.562$ ;  $N_a$  for vibration direction  $[100]$  is 1.640. Color blue in bulk and in transmitted light with absorption  $Z > Y > X$ .

30. Di(Tetramethyl Ammonium)Plutonium (IV) Hexa-Chloride.

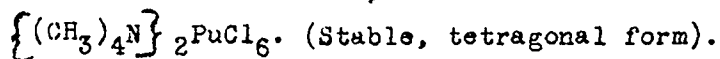

Prepared according to H. H. Anderson<sup>(18)</sup> by adding

tetramethyl ammonium chloride to a solution of Pu (IV) in hydrochloric acid and adding methyl alcohol. Final conditions: Tetramethyl ammonium chloride 240 g.p.l., Pu (IV) 60 g.p.l., HCl 1.5 M, CH<sub>3</sub>OH 60% by volume. Together with Cs<sub>2</sub>PuCl<sub>6</sub> (7) and corresponding quinolinium and pyridinium salts, described in the following, this compound is regarded by Anderson as a salt of chloroplutonic acid (H<sub>2</sub>PuCl<sub>6</sub>).

Crystal Morphology: Tetragonal. Habit dipyramidal.

Optical Properties: Uniaxial positive. Refractive indices: No = 1.528; Ne = 1.534. Color in bulk orange, yellow in transmitted light with absorption E > 0.

31. Di-(Tetramethyl Ammonium)Plutonium(IV)Hexa-Chloride .  
(Unstable, isometric form).

Octahedral isotropic crystals were also observed in the preparation described above under (30). These crystals invariably showed signs of incipient alteration. With time they changed to the birefringent, tetragonal variety. This change took place even in preparations mounted in plastics, such as "Permunt". The refractive index of the isotropic crystals was 1.52, color yellow.

32. Di-(Tetraethyl Ammonium) Plutonium (IV) Hexa-Chloride.

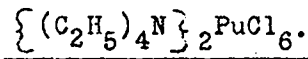

*Mallard 20  
147 ± 3  
D 73 1/2 ± 1 1/2*

Prepared by adding tetraethyl ammonium chloride to a solution of Pu (IV) in 6 M HCl, and diluting with ethyl alcohol.

Crystal Morphology: Monoclinic, pseudo-isometric (a and c near 1, b near 90°). Crystal habit: Pseudo-octahedral by development of  $o\{111\}$  and  $p\{\bar{1}11\}$ , or simulating cubo-octahedrons by development, in addition to the above, of the three pinacoids  $a\{100\}$ ,  $b\{010\}$  and  $c\{001\}$ . Form.  $q\{011\}$  also frequently present (Figure 6).

*-2A ± 1/2 Mallard*

Optical Properties: Biaxial negative with  $2V = 20^\circ$  (estimated). Optic orientation:  $X = b$ ,  $Z \wedge [001]$  very small. *Extreme* Strong dispersion of optic axes  $r > v$ , and (pronounced crossed dispersion of the bisectrices) giving rise to abnormal interference colors in views normal or inclined to  $[010]$ . Refractive indices:  $N_g = 1.569$ ;  $N_m = 1.568$ ;  $N_p = 1.560$ .

Color yellow, non-pleochroic.

33. Di-Pyridinium Plutonium(IV)Hexa-Chloride.  $(C_5H_5NH)_2PuCl_6$ .

Prepared according to Anderson<sup>(18)</sup>.

Crystal Morphology: Triclinic. Crystal habit tabular or equant.



Optical Properties: Biaxial negative with  $2V = 20^\circ$  (measured). Tabular crystals give a slightly off-center acute bisectrix interference figure. Dispersion of optic axes  $v > r$ , strong. Refractive indices:  $N_g = 1.744 \pm 0.004$ ;  $N_m = 1.736 \pm 0.004$ ;  $N_p = 1.596$ . Color in bulk yellow. Pleochroic with X = faint pink, Y and Z lemon yellow.

34. Di-Quinolinium Plutonium (IV) Hexa-Chloride.

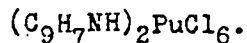

Prepared according to Anderson<sup>(18)</sup>.

Crystal Morphology: Triclinic. Habit equant, bounded by three pinacoids. The three zone axes make angles of  $90^\circ$ ,  $80^\circ$ , and  $70^\circ$  with each other (Figure 7).

Optical Properties: Biaxial negative. Optic axial angle  $2V = 35^\circ$  (estimated). Extinction angles in the three prominent aspects of the crystals are shown on Figure 7.

Refractive indices:  $N_g = 1.84 \pm 0.005$ ;  $N_m = 1.83 \pm 0.005$ ;  $N_p = 1.578$ . Color yellow in bulk. Pleochroic with X = pink, Y and Z lemon yellow.

35. Plutonium (IV) 8-Hydroxyquinolate.

Prepared according to R. L. Patton<sup>(24)</sup> (pp.16-19) by adding an alcoholic solution of 8-hydroxyquinoline to a  $PuCl_4$

solution buffered with acetic acid and sodium acetate.

Crystal Morphology: Orthorhombic, ratio  $\underline{c} : \underline{a} = 0.65$ .

Crystal habit: Blades flattened on  $\{010\}$ , elongated along  $[001]$ . Forms observed:  $b \{010\}$ ,  $a \{100\}$ ,  $r \{101\}$  (Figure 8).

Optical Properties: Biaxial positive with a small optic axial angle. Optic orientation:  $Z = \underline{a}$ ,  $Y = \underline{b}$ ,  $X = \underline{c}$ .

Refractive indices:  $N_g > 1.86$ ;  $N_m$  and  $N_p = 1.766 \pm 0.004$ .

Color in bulk reddish brown. Pleochroic with  $X = Y = \text{brown}$ ,  $Z = \text{green}$ .

36. Plutonium (III) Picrolonate (Orthorhombic Form).

Prepared according to Patton<sup>(24)</sup> (pp.16-19) by precipitation with a hot aqueous solution of picrolonic acid from a solution of  $\text{PuCl}_3$  buffered with ammonium acetate and acetic acid to a pH of 4-6. The crystals formed decomposed to an unresolved greenish mass on washing with water.

Crystal Morphology: Orthorhombic. Ratio  $\underline{c} : \underline{a} = 1.03$ .

Crystal habit: Vertically striated prisms  $\{110\}$  terminated by  $c \{001\}$  or  $r \{101\}$ . Also tabular, flattened on  $b \{010\}$  with  $m \{110\}$ ,  $a \{100\}$ ,  $r \{101\}$  and  $c \{001\}$  (Figure 9).

Optical Properties: Biaxial positive. Optic orientation:  $Z = \underline{c}$ ,  $Y = \underline{b}$ ,  $X = \underline{a}$ . Strong dispersion of optic axes  $r > v$ .

Refractive indices:  $N_g = 2.03 \pm$  ;  $N_m = 1.760 \pm 0.005$ ;  
 $N_p = 1.650 \pm 0.003$ . The index  $N_g$  could not be determined directly and was estimated by a modification of Ambronn's method<sup>(1)</sup> (p.253-254). Color in bulk apple green.  
 Pleochroic with Z = yellow, Y = olive green, X = light green, nearly colorless.

37. Plutonium Picrolonate (7). (Triclinic Form).

This compound was precipitated by picrolonic acid from solutions of Pu (III) in 0.01 M HCl or 0.03 M acetic acid, i.e. at lower pH than used to precipitate the orthorhombic form. The crystals formed were stable on washing with water.

Crystal Morphology: Triclinic. Crystal habit: Plates bounded by three pinacoids and characterized by a vertex angle of  $46^\circ$ .

Optical Properties: Biaxial negative with the extinction angle for the fast ray  $14^\circ$  in the acute angle on prominent pinacoid. Strong crossed dispersion of the bisectrices.

Refractive indices in the two extinction directions of the prominent aspect:  $1.820 \pm 0.005$ ;  $1.640 \pm 0.003$ . Color in bulk dark brown. Strongly pleochroic with X = brown, Z = tannish green.

## REFERENCES

- (1) A. Johannsen: "Manual of Petrographic Methods." 2nd Ed. McGraw Hill, 1918.
- (2) M. Reinhard: "Universaldrehtischmethoden", Verlag von B. Wepf und Cie, Basel, 1931.
- (3) A. N. Winchell: "The Microscopic Characters of Artificial Inorganic Solid Substances or Artificial Minerals." 2nd Ed. John Wiley and Sons, 1931.
- (4) E. E. Jelley: "Microscopy", Chapter XI in "Physical Methods of Organic Chemistry" edited by Weissberger, Interscience Publishers, Inc., 1945.
- (5) E. E. Jelley: "Application of the Grating Microspectrograph". Ind. Eng. Chem., Analyt. Ed., vol. 13, pp. 196-203, 1941.
- (6) "Crystallographic Data Contributed by Armour Research Foundation of Illinois Institute of Technology". Anal. Chem. 20(1948) 274-277.
- (7) B. B. Cunningham: "The Compounds of Plutonium". CN-3551. July, 1946.
- (8) J. D. H. Donnay: "Rules for the Conventional Orientation of Crystals". Am. Mineralogist 28(1943) 313-328, 470.
- (9) T. V. Barker: "Systematic Crystallography, An Essay on Crystal Description, Classification and Identification". Murby, London, 1930.
- (10) P. Terpstra, J. D. H. Donnay, J. Melon and W. J. van Weerden: "Studies on Barker's Determinative Method of Systematic Crystallography". Zeitschrift fuer Kristallographie, Mineralogie und Petrographie, A87 (1934) 281-305.
- (11) A. N. Winchell: "Elements of Optical Mineralogy". 3rd Ed. John Wiley and Sons, 1933.

- (12) A.N. Winchell: "The Optical Properties of Organic Compounds". The University of Wisconsin Press. Madison, 1943.
- (13) "Report of the Committee on Nomenclature". Am. Mineralogist, 21(1936) 188-191.
- (14) C. Palache, H. Berman and C. Frondel: "The System of Mineralogy". 7th ed. vol. I. John Wiley and Sons, 1944.
- (15) Kroner and Spector: CN-2213.
- (16) Hamaker and Koch: CN-3018.
- (17) W. H. Zachariasen: "X-ray Diffraction Studies of Plutonium Compounds". CN-2069 (A-3011) August, 1944.
- (18) H. H. Anderson: "Dicesium Plutonium Hexachloride and Related Compounds". ANL-4056.
- (19) W. H. Zachariasen: "Crystal Chemical Studies of the 5-f Series of Elements. II "The Crystal Structure of  $Cs_2PuCl_6$ ". Acta Crystallographica, Vol. I, part 5, pp. 268-269. 1948.
- (20) P. Groth: "Chemische Kristallographie", 5 volumes, Engelmann, Leipzig, 1906-1921.
- (21) L. B. Asprey. CN-3001, May, 1945.
- (22) E. M. Chamot and C. W. Mason: "Handbook of Chemical Microscopy". John Wiley and Sons, 1940.
- (23) L. I. Katzin: "Survey of the Chemistry of Plutonium. CK-2240. 1944.
- (24) R. L. Patton, CK-1371
- (25) H. H. Anderson. CN-2888, April, 1945.

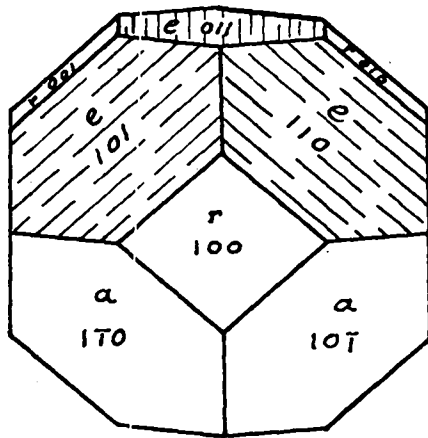

Fig. 1: Crystal Habit of Ammonium Plutonium Di-Oxy Tri-Nitrate. Projection on  $r$  (100).

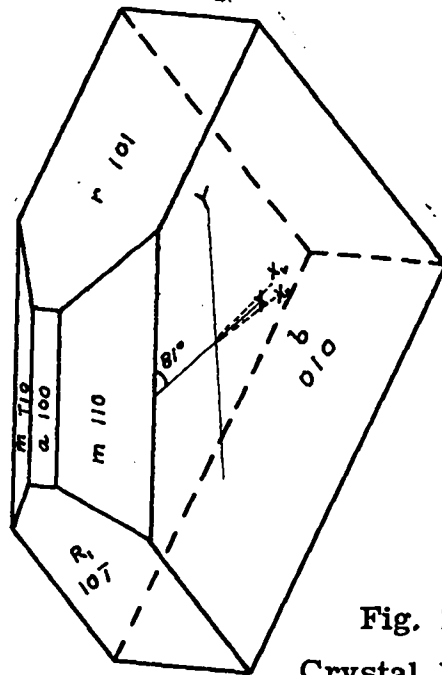
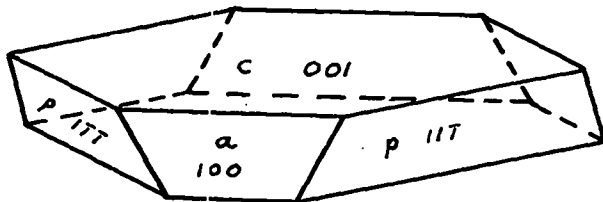
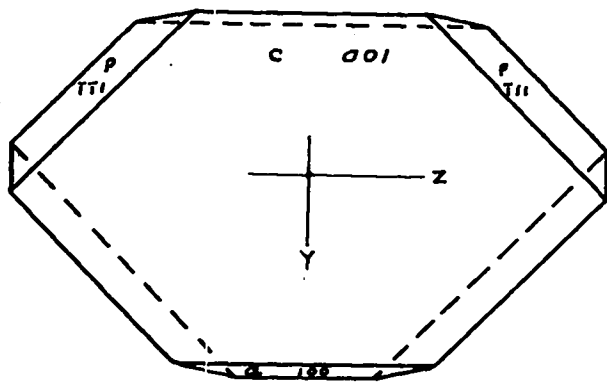

Fig. 2: Crystal Habit and Optic Orientation of Di-Ammonium Plutonium Hexa-Nitrate.



(a) Conventional Projection.



(b) Projection on C (001).

Fig. 3: Crystal Habit of Magnesium Plutonium Hexa-Nitrate Octo-Hydrate.

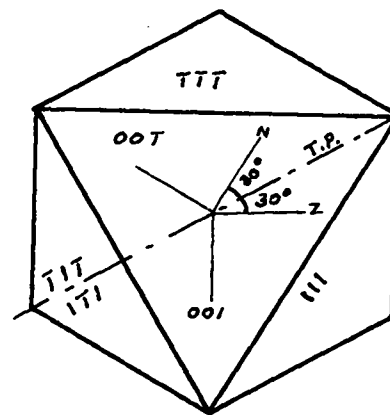

Fig. 4: Simple Twin of Sodium Zinc Plutonyl Acetate. Projection on C (001).

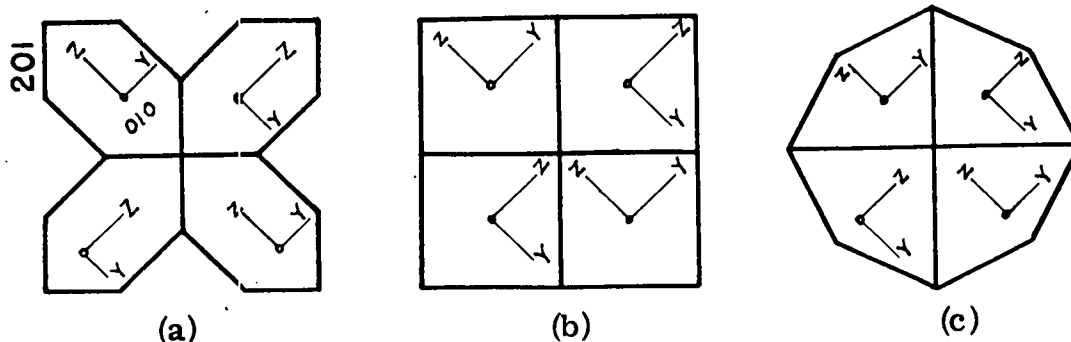

Fig. 5: Crystal Habit and Optic Orientation of Plutonium Di-Oxalate Hexahydrate.

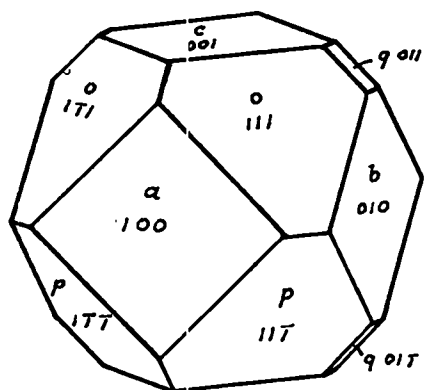

Fig. 6: Crystal Habit of Di-(Tetra-Ethyl Ammonium) Plutonium Hexa-Chloride.

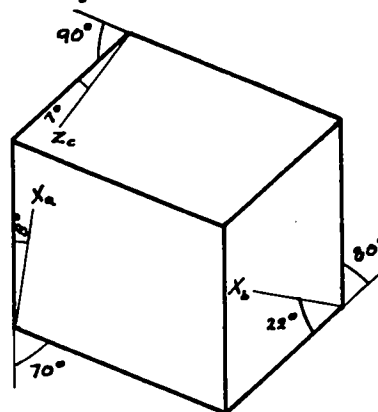

Fig. 7: Crystal Habit and Extinction Angles of Di-Quinolinium Plutonium Hexa-Chloride.

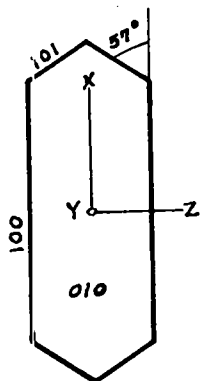

Fig. 8: Crystal Habit and Optic Orientation of Plutonium 8-Hydroxyquinolate.

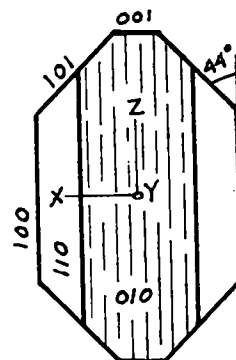

Fig. 9: Crystal Habit and Optic Orientation of Plutonium (III) Picrolonate.



Figure 10

Di-Cesium Plutonium Hexa-Chloride 150X



Figure 11

Magnesium Plutonium Hexa-Nitrate 150X



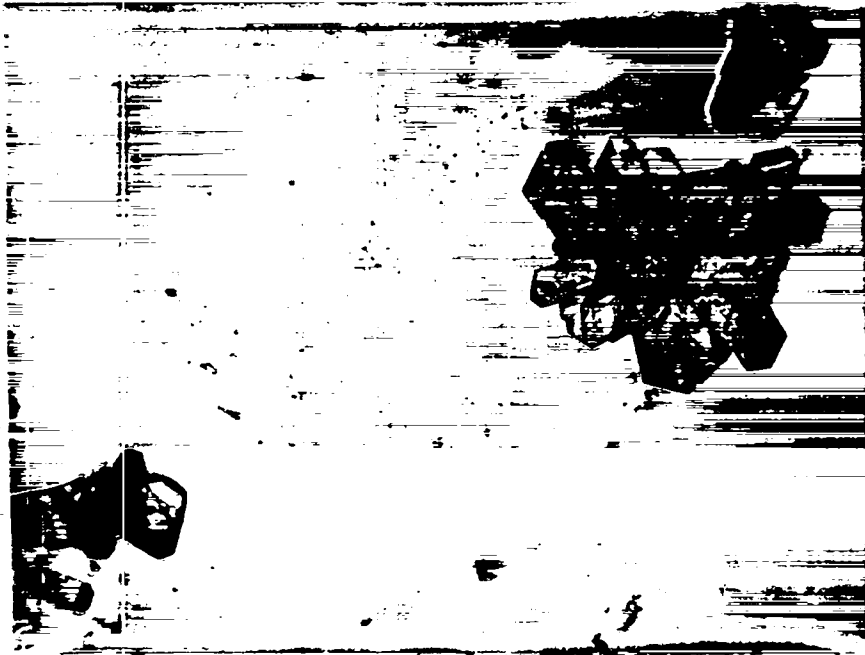

Figure 12

Di-Ammonium Plutonium Hexa-Nitrate .150X

Twinned plates and simple crystal  
(lower left) showing hemihedral development.



Figure 13

Di-Ammonium Plutonium Hexa-Nitrate 150X

(Crossed polarized light, 1st order red compensator)  
Plate showing repeated twinning.



Figure 14

Plutonium (III) Sulfate? (triclinic form) 150X

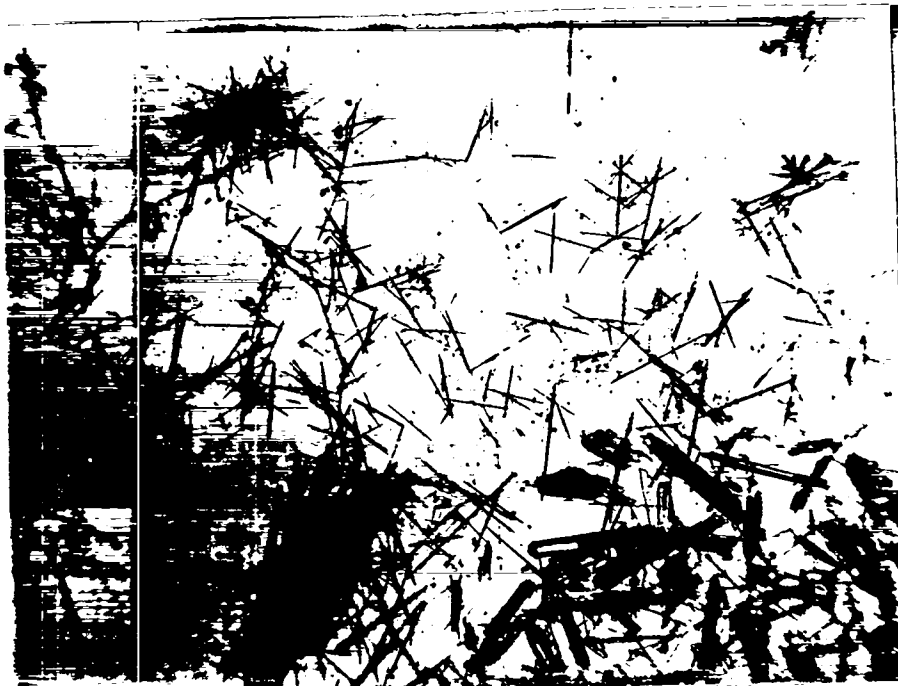

Figure 15

Di-Plutonium Tri-Sulfate Hepta(?) -Hydrate 150X

Same preparation as shown on Figure 14 after admitting water vapor. Corroded remnants of the triclinic crystals seen in the lower right hand corner.



Figure 16

Plutonium Di-Sulfate Tetra-Hydrate 500X



Figure 17

Di-Plutonium Tri-Oxalate Nono(?)Hydrate 500X



Figure 18

Plutonium Di-Oxalate Hexa-Hydrate 500X

Showing transition from simple crystals to cruciform  
twins and to square twinned plates.

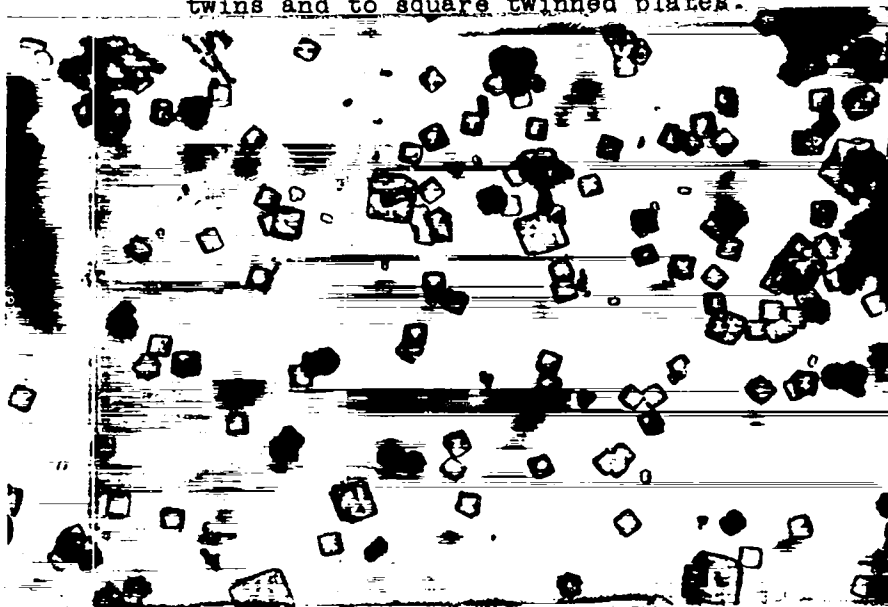

Figure 19

Plutonium Di-Oxalate Hexa-Hydrate 150X

Typical development as pseudo-tetragonal twinned plates.



Figure 20

Plutonium Oxalato-Chloride 150X

DOCUMENT ROOM

REC. FROM *eng-1*

DATE *11-4-49*

REC.  NO. REC. \_\_\_\_\_